

# ***GAMMA***<sup>®</sup>

## **9900 Els STRINGING MACHINE 6 PT SM SC MOUNTING**



### **OWNER'S MANUAL**

Issue 1 - June 2015

# **GAMMA®**

## **9900 Els OWNER'S MANUAL**

### **TABLE OF CONTENTS**

WARRANTY.....	PAGE 2
FEATURES .....	PAGE 3
UNPACKING & ASSEMBLY INSTRUCTIONS.....	PAGE 4
POWER CONNECTION & CONTROLS.....	PAGE 10
CONTROL PANEL FUNCTIONS AND FEATURES.....	PAGE 11
DISPLAY SCREEN.....	PAGE 12
MACHINE FUNCTIONS.....	PAGE 13
STRING GRIPPER OPERATION .....	PAGE 18
MOUNTING THE FRAME.....	PAGE 19
STRINGING THE FRAME .....	PAGE 21
STRING LENGTH METER .....	PAGE 24
ADDITIONAL FEATURES.....	PAGE 25
PATHFINDER AWL.....	PAGE 26
MAINTENANCE & ADJUSTMENTS .....	PAGE 27
TROUBLESHOOTING TIPS.....	PAGE 29
PARTS LIST.....	PAGE 30
PARTS DRAWING .....	PAGE 31

### **LIMITED WARRANTY**

GAMMA SPORTS warrants to the original purchaser that the 9900 Els stringing machine ("EQUIPMENT") purchased is free from defects in materials and workmanship for a period of five (5) years from the date of original purchase for mechanical parts (excluding electrical parts and string clamps), and for a period of one (1) year from the date of purchase for all electrical parts and string clamps. Should any defects develop under normal use within the specified time periods, GAMMA will at its option, repair or replace the defective EQUIPMENT provided it is returned to GAMMA prepaid at the purchaser's expense. This warranty does not apply to any damage or defect caused by negligence, abuse, misuse, unauthorized alteration, shipping, handling, or part wear and tear as a result of normal use.

Routine maintenance, adjustment, and cleaning required to ensure proper operation are the responsibility of the purchaser and are not covered under the terms of this warranty. These include, but are not limited to: String Clamp adjustment, as described on page 28, Clamp Base adjustment, as described on page 28, and the cleaning procedures listed on page 29.

GAMMA's obligation under this warranty is limited to repair or replacement of defective EQUIPMENT, and no one is authorized to promise any other liability. GAMMA shall in no event be liable for any incidental or consequential damages.

To return defective EQUIPMENT, a return authorization (RA#) must be obtained from a GAMMA customer service representative. The RA# must be marked on the outside of the shipping carton being returned. All returns must be shipped prepaid by the customer to GAMMA. Please retain the original shipping carton and packing materials for any future shipments. GAMMA will not be responsible for machines which are not sent in the original undamaged packaging.

A GAMMA Care Service Plan is also available through GAMMA customer service, call 800.333.0337 for details.

# MACHINE FEATURES



## MACHINE FEATURES

- ❖ Electric Constant Pull Tensioner with 11.0 to 90.0 lbs Tension Range
- ❖ Digital Tension Setting with LCD Display
- ❖ Auto Start Quick Closing Linear String Gripper
- ❖ Professional Six Point Self Centering Suspension Mount Racquet Mounting System- Accommodates All Racquets
- ❖ Auto-Release Cam-Lock Swivel Base Clamps
- ❖ 4 Tooth Universal String Clamps
- ❖ High Strength Extruded Aluminum Frame with Durable FRP Cover with Extra Large, Deep Padded Tool Tray
- ❖ Turntable Clutch to Adjust Rotation Friction
- ❖ Convenient Foot Actuated Tensioner Switch
- ❖ String Length Meter



# 9900 EIs

## Unpacking Instructions & Contents

### Instructions for Unpacking and Preparing for Assembly

The stringing machine is shipped in three cartons, a large master carton for the stringing machine base with tensioner module and accessories, a medium carton for the turntable and mounting system and a smaller carton for the floor stand post and base legs. **Please save the cartons and packing materials for possible shipments in the future.** Gamma Sports cannot be responsible for machines that are not returned, shipped in their original, undamaged packaging. The tools you will need to assemble the machine are provided with the machine. Due to the weight of the tensioner unit, you may need the assistance of someone to help lift the tensioner unit out of the carton.

Once the cartons are opened, remove all inner cartons and check to be sure that all parts are present and accounted for.

#### Contents of Electric Floor Stand (MMU3-20)

- (1) Column Assembly
- (4) Legs
- (4) Leveling Feet
- (4) M8 x 30 Flat Head Screws
- (4) M8 x 35 Cap Screws
- (4) M6 x 20 Cap Screws
- (1) String Reel Holder (M8 Threaded Pin), (1) Knob, (8) Spacers, & (2) M8 Washers

#### Contents of Mounting System Carton (MMU3-25)

- (1) Turntable Assembly w/ String Clamp Base and Mounting Stands w/ Frame Support Slide, Side Supports, and Adapters
- (2) String Clamps
- (1) Package of spare plastic adapters for frame and mounting system supports

#### Contents of Machine Base Carton (MMU3-18)

- (1) Stringer Assembly Unit w/ Tensioner Module
- (1) Power Cord
- (1) AC Adaptor
- (1) Foot Pedal Tensioner Switch
- (4) Rubber Feet for Table Top Use
- (1) Wiring Harness for Electric Floor Stand Connection
- (1) Stringing Tool Set - Includes 1 ea Diagonal Cutter, Bent Nose Pliers, Straight Nose Pliers, Starting Clamp, Straight Awl & Pathfinder Specialty Awl
- (1) Tools for assembly and maintenance

# ASSEMBLY INSTRUCTIONS

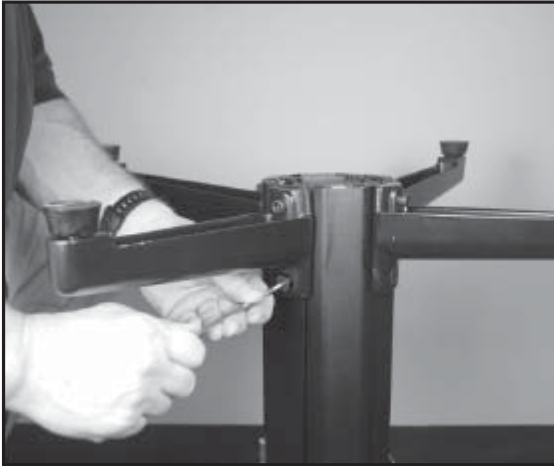

## Floor Stand Leg Assembly

The stringing machine uses a four leg floor stand design. The legs must be assembled to the Lower Column before use. Remove all parts from the shipping carton to confirm that contents match the parts list.

Align the holes in the Leg Flange with the matching holes in the Lower Column. Secure the leg with one M8x30 flat head screw through the upper hole, and one M8x35 socket head cap screw through the bottom hole. Repeat this procedure for the three remaining legs.



## Mounting the Floor Stand to the Machine Base

The Floor Stand can be mounted to the machine base by laying the machine on the floor to align the 4 holes in the flange plate to the machine base or by setting the machine on top of the upright Floor Stand. Note: If mounting the machine base to the top of the upright Floor Stand use the help of an assistant to balance the machine base while aligning and tightening the four cap bolts. Orient the floor stand to the machine so that the boss for the string reel will be on the left side of the machine base and the floor stand power switch is at the rear side of the machine base.

**CAUTION:** To prevent damage to the string gripper, never lift or move the machine by the string gripper.

# ASSEMBLY INSTRUCTIONS

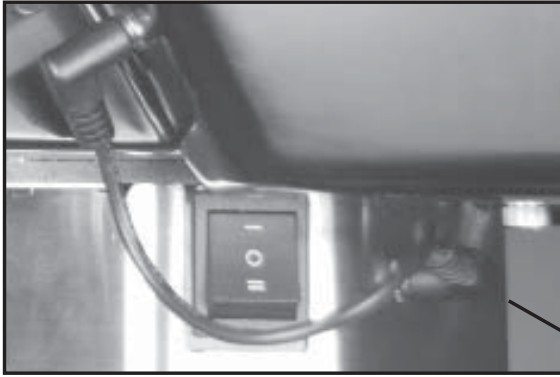

## Floor Stand Power Connection

Plug the Floor Stand power cord from bottom left side of the tensioner housing into the socket on the Floor Stand column.

Floor Stand Cord Connection



## Floor Stand Height Adjustment

The electric floor stand permits height adjustments from 39" to 49". The machine height can be raised or lowered by depressing the rocker switch Up or Down. When the desired height is reached set the rocker switch to the neutral position.



# ASSEMBLY INSTRUCTIONS

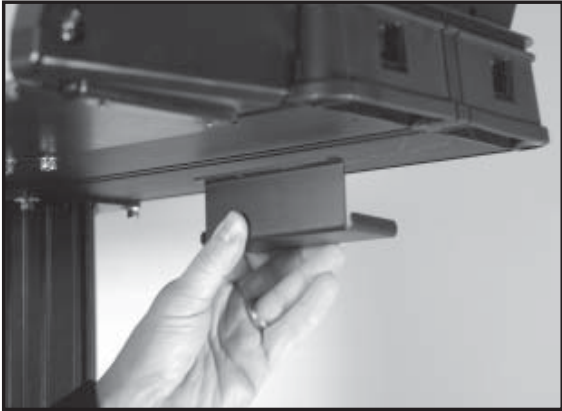

## AC Power Adapter Storage Shelf

The AC Power Adapter Storage Shelf provides a means to secure and protect the power adapter by storing it safely under the machine base. This will reduce a potential tripping hazard as well as eliminate potential damage to the AC Power Supply if laying on the floor.

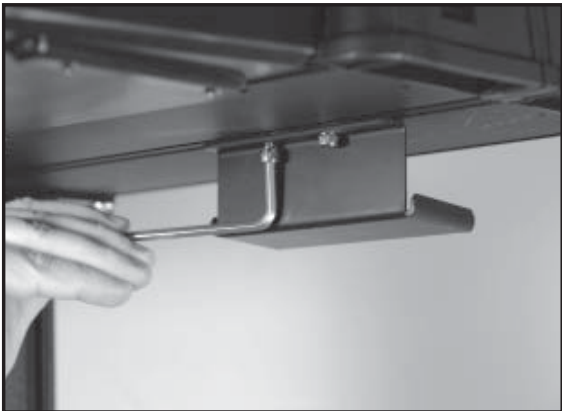

## AC Power Adapter Storage Shelf

To mount the Storage Shelf to the underside of the base, align the holes in the storage shelf bracket with the holes in the base. Use a 6 mm hex wrench to tighten the two hex head cap screws.

NOTE: To avoid risk of damaging the threads in the base, DO NOT OVERTIGHTEN.



## AC Power Adapter Storage Shelf

Place the AC Power Adapter into the Storage Shelf. Coil the pin connector cable and tuck it between the top of the AC Power Adapter and the machine base.



# ASSEMBLY INSTRUCTIONS

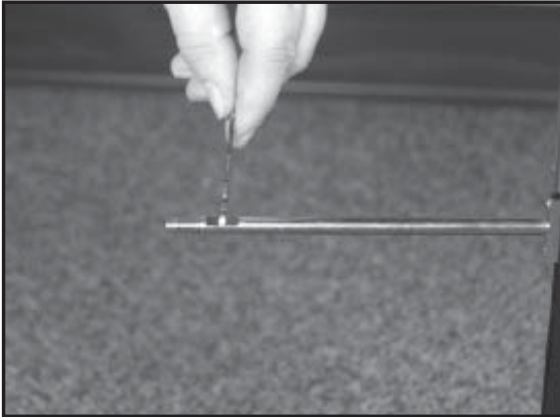

## String Reel Installation

The String Reel Holder pin is an 8 mm rod with threads on both ends and flat surfaces machined on one end. Thread the end of the pin without the flat surfaces into the threaded boss on the right side of the Lower Column. Using the M6 open end wrench positioned on the flat surfaces, securely tighten the pin to the Lower Column.

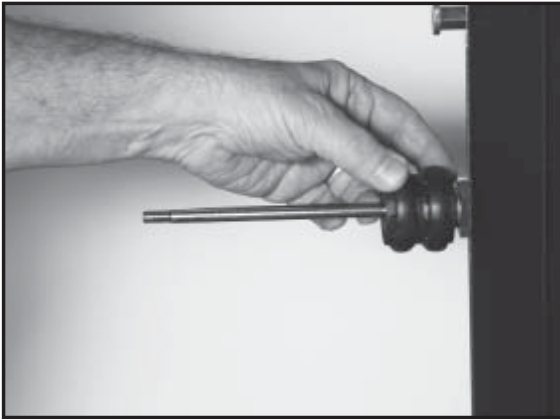

The String Reel Holder can hold up to 4 reels of string (depending on the size of the string reel). Before placing the first reel on the rod, slide two spacers over the pin and slide them to the connector on the Lower Column.

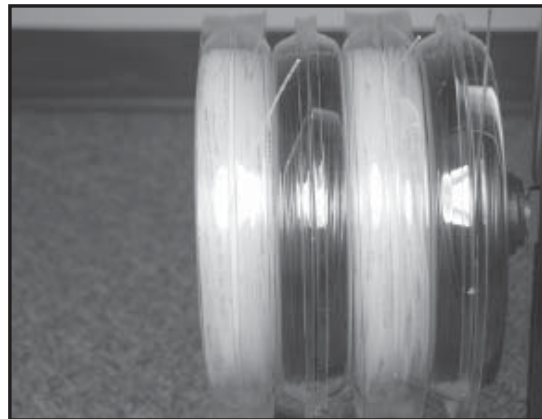
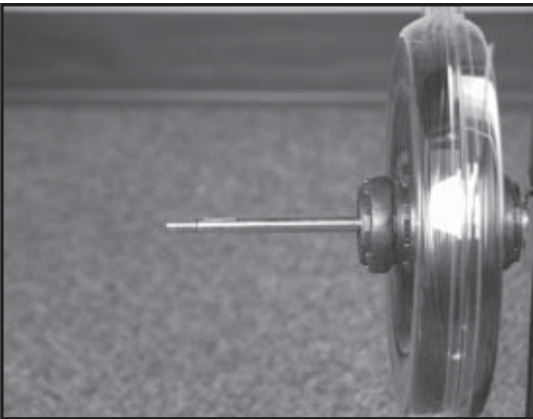

After the first reel is placed onto the rod, place two spacers between each reel to provide enough space between reels to allow them to turn freely without rubbing against one another. (To provide a smooth feed to the String Length Meter, place the reels on the rod so the string spools off the reel from the underside of the reel).

After the last reel is installed, place the two M8 washers on the pin and attach the threaded knob to the end of the rod.



# ASSEMBLY INSTRUCTIONS

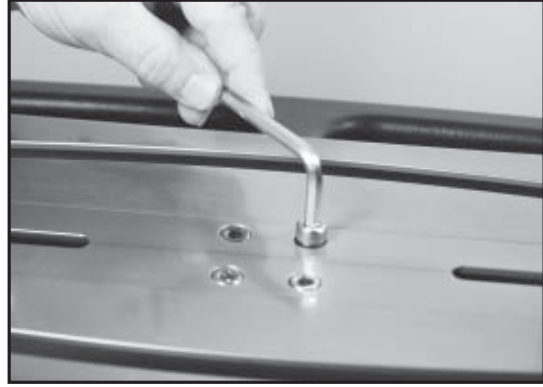
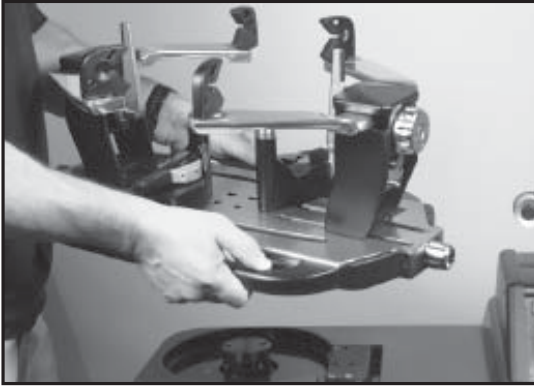

## **Turntable and Mounting System Installation**

To install the Turntable position the Turntable over the turntable pin and align the holes in the turntable with the holes in the turntable pin. Insert the bolts through the holes in the turntable and turntable pin and tighten with an M6 hex wrench.

# STRING CLAMP INSTALLATION

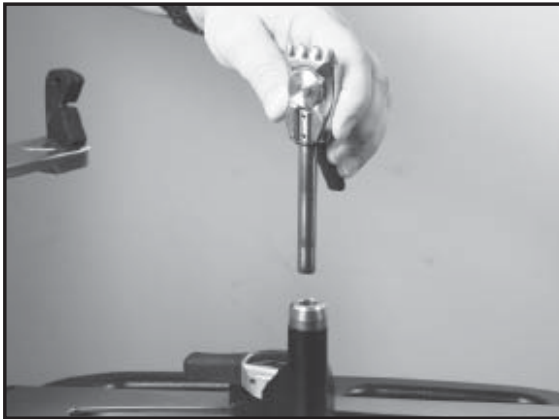

## **String Clamp Installation**

The post of the String Clamp and tube of the String Clamp Base may be treated with grease to provide protection against corrosion during shipping and while in storage. Remove any excessive grease with a clean cloth prior to use. The post and tube may also be cleaned with isopropyl alcohol. After this type of thorough cleaning, the post and tube should be treated with a light coating of machine oil to protect the surfaces against corrosion and to ensure smooth operation.

# POWER CONNECTION & CONTROLS

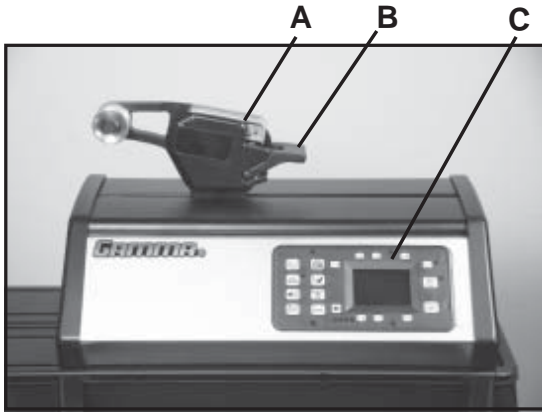

## Front Panel Features

- A - String Gripper
- B - Tension Lever Switch
- C - Control Panel with LCD Display

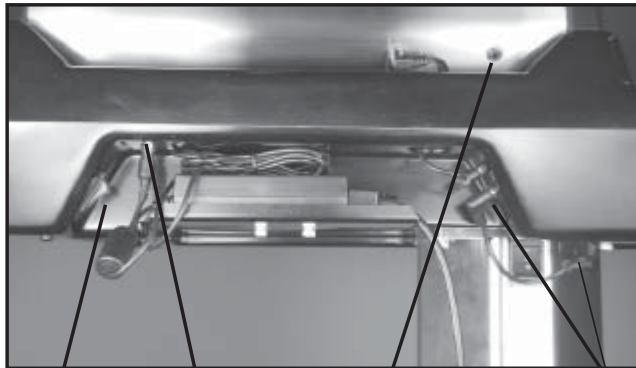

## Back Panel Features

- D - Power Switch
- E - A/C Power Cord Socket
- F - Foot Pedal Switch Socket
- G - Floor Stand Power Socket

## Instructions for Power Connection and Controls

**CAUTION !** Before connecting to the power supply, check the voltage source that the machine is being connected to. The acceptable range of input voltages for this machine is between 100 V and 240 V @ 50 to 60 Hz. If you have any questions regarding the input voltage supply for your area, please ask your electric utility company.

To install the power cord, insert the female end of the power cord into the AC Adapter and then insert the female end of the cord from the AC Adapter into the A/C Power Cord Socket "E" located on the back side below the tensioner. Plug the male end of the power cord into a grounded power outlet. When using extension cords, use grounded heavy duty extension cords rated for 15 AMP service.

Insert one end of floor stand power cord into the Floor Stand Power Socket "F" and the other end into the power socket next to the rocker switch on the top column of the floor stand.

Connect the Foot Pedal Switch by inserting the male pin at the end of the Foot Pedal Switch cord into the Foot Pedal Switch Socket "G" located on the back panel of the Tensioner.

Switch on the machine by pressing the On-Off Power Switch "D". At start-up, the machine will perform a self diagnostics check.

**WARNING! FOR INDOOR USE ONLY.  
NEVER OPEN UNIT WITH POWER CONNECTED.  
CHILDREN SHOULD NEVER BE PERMITTED TO OPERATE THIS MACHINE  
WITHOUT ADULT SUPERVISION.**

# CONTROL PANEL FEATURES



**ESC Button** - Press to return to the Stringing Screen from the Settings Screen, String Length Meter Screen or to cancel a change being made to one of the functional settings.



**KNOT Button** - Press once to enable and display the Knot Icon - Press again and hold while the Knot icon is displayed to highlight the setting and make changes.



**SOUND Button** - Press to turn on or turn off beeper. When in the Settings Screen, the Sound Icon will include an "X" when Beeper is disabled and ")))" when the beeper is enabled.



**PULLING SPEED Button** - Press once to display the Pulling Speed Icon - Press again and hold while the Pulling Speed Icon is displayed to highlight the setting and make changes.



**MAIN/CROSS String Button** - Press to select and display the Main String Tension Setting or the Cross String Tension Setting.



**PRE-STRETCH Button** - Press once to enable and display the Pre-stretch Icon - Press again and hold while the Pre-stretch Icon is displayed to highlight the setting and make changes.



**STRING LENGTH METER Button** - Press to enable and display the String Length Meter - Pressing again will toggle the measurement units between feet (FT) and meters (M).



**LBS/KG Button** - Press to toggle the Tension Setting between LBS and KG.



**ENTER Button** - Press to confirm and save changes to any machine settings and to zero the String Length Meter.



**RETURN Button** - Press to return to the Stringing Screen from the Settings Screen, String Length Meter Screen or to cancel a change being made to one of the functional settings.



**MEMORY Button** - Press to scroll through 9 programmable Memory Settings (M1-M9) - Press and hold for 5 seconds to enable Basic Stringing Mode (M0).



**F1 Button** - Press to display the Settings Screen to view and make changes to any of the machine settings. Pressing and holding the F1 button for 5 seconds will display the Information Screen, which includes the total number of strings pulled on the machine. Pressing the ESC or RETURN button will exit from the Information Screen.



**F5 Button** - Press to reverse the order in which the Memory Settings are scrolled through - When the LED is illuminated the Memory Settings will scroll in decreasing order.



**F2-F3-F4 Buttons** - Press to increase String Tension values in the tens place (F2), units place (F3) and tenths place (F4) and press to increase setting values for Knot, Pre-stretch and Speed.



**F6-F7-F8 Buttons** - Press to decrease String Tension values in the tens place (F6), units place (F7) and tenths place (F8) and press to decrease setting values for Knot, Pre-stretch and Speed.

# DISPLAY SCREENS



## Language Selection Screen

At start-up, if a language other than English is desired, press any one of the F6-F8 buttons when the Start-up Screen appears to change to the Language Selection Screen. Pressing any one of the F2-F8 buttons will scroll through the available languages. When the desired language is highlighted, confirm by pressing the Enter Button.



## Self Diagnostic Test Screen

During start-up, the machine will automatically perform a self-diagnostic test as the gripper moves from left to right and back to the left. The diagnostic checks will appear on the display in the selected language.



## Settings Screen

Pressing the F1 button will open the Settings Screen to view all current machine settings on the same screen and to quickly make changes to any of the settings. If no buttons are pressed within 10 seconds the Settings Screen will revert to the Stringing Screen.



## Stringing Screen

The Stringing Screen displays the tension settings for the main strings and cross strings. The large tension value on the display and the highlighted Main String or Cross String Icon will be the active tension setting. The machine only pulls tension when the Stringing Screen is displayed.



# MACHINE FUNCTIONS



## Setting Tension

To change the Tension Setting press F2 to increase the Tension Setting in the tens place, F3 to increase the Tension Setting in the units place and F4 to increase the Tension Setting in the tenths place. To decrease the Tension Setting press F6 to decrease the Tension Setting in the tens place, F7 to decrease the Tension Setting in the units place and F8 to decrease the Tension Setting in the tenths place.

**NOTE: Continuing to press the buttons for the lower place values will increase or decrease the higher place values.**



## Setting LBS-KGS

To select LBS (pounds) or KG (kilograms), pressing the LBS-KG Button will toggle back and forth between LBS and KG. The tension setting can be switched between LBS and KG at any time and the tension setting will be displayed accordingly.



## Setting Different Tensions for Main Strings and Cross Strings

To preset Tension Settings for the Main Strings and Cross Strings, press the MAIN/CROSS String Button to toggle between the Main String and Cross String tension settings.

To set the tension value for the Main Strings, press the MAIN/CROSS String Button and

when the Main String Icon on the display is highlighted, set the Main String tension value. To set the tension value for the Cross Strings, press the MAIN/CROSS String Button and when the Cross String Icon on the display is highlighted and set the Cross String tension value. Once the desired Main String and Cross String tension values are entered, to save the settings in the active Memory Setting press the ENTER button.

**NOTE: The active tension setting is displayed by the large numbers on the screen for whichever string icon is highlighted on the screen.**

# MACHINE FUNCTIONS



## Permanent Memory Settings

There are 9 permanent Memory Settings that can be used to store 9 combinations of machine settings. Pressing the MEMORY button will scroll through the 9 Memory Settings in increasing order. To reverse the scrolling order, press the F5 button. The Blue LED will illuminate and the scrolling order will be in decreasing order.

For any Memory Setting you can enter a specific Main String Tension, Cross String Tension, Knot String Setting, Pre-stretch Setting and Pulling Speed Setting for a specific application, such as type of string or set-up. Each setting can be entered and saved according to the instructions on the previous and following pages.



## Basic Stringing Mode

A Basic Stringing Mode can also be enabled by pressing and holding the Memory Button for 5 seconds. When enabled the Blue LED illuminates next to the Memory Button and an M0 appears on the screen above the Speed Icon.

The M0 Basic Stringing Mode is used when you do not wish to use or alter any of the permanent Memory Settings that were pre-programmed and saved for specific applications. Settings are not permanently saved when in the M0 Basic Stringing Mode. When the machine is turned off all settings will revert back to the default settings when the machine is turned back on.

To change back to the Permanent Memory Setting Mode, press and hold the Memory Button for 5 seconds until the Blue LED goes out and one of the 9 permanent Memory Settings appears above the Speed Icon.

# MACHINE FUNCTIONS



## Setting the Pulling Speed from the Stringing Screen

To change the Pulling Speed Setting while in the Stringing Screen, first press the PULLING SPEED button to display the Pulling Speed Icon and Pulling Speed Setting on the display. Then press and hold the PULLING SPEED button again until the Pulling Speed Setting is highlighted above

the Pulling Speed Icon. Press any of the F2, F3 or F4 buttons to increase the Pulling Speed Setting in 10% increments and any of the F6, F7 or F8 buttons to decrease Pulling Speed Setting in 10% increments. When the desired Pulling Speed Setting is displayed, press the ENTER button to save the Pulling Speed Setting for the active Memory Setting.

**NOTE: Selectable Pulling Speeds range from 30% (Slowest Pulling Speed) to 100% (Fastest Pulling Speed) in 10% increments.**



## Setting the Pulling Speed from the Settings Screen

To change the Pulling Speed Setting from the Settings Screen, first press F1 to display the Settings Screen. After the Settings Screen appears on the display, press the PULLING SPEED button to highlight the Pulling Speed Setting above the Pulling Speed Icon. Press any of the F2, F3 or F4 buttons to increase the Pulling Speed Setting in 10% increments

and any of the F6, F7 or F8 buttons to decrease Pulling Speed Setting in 10% increments. After the desired Pulling Speed Setting is entered press the ENTER button to accept and save the Pulling Speed Setting for the active Memory Setting. If no other buttons are pressed within 10 seconds the display will return to the Stringing Screen. Pressing the ESC or RETURN button will immediately return to the Stringing Screen.

**NOTE: The slowest pulling speed should always be used when stringing very stiff strings, such as aramid fiber strings. Stringing at slower pulling speeds will help to reduce tension loss over time for any string types, especially for strings that tend to lose tension more quickly than others.**



# MACHINE FUNCTIONS



## Pre-stretch Function

The Pre-stretch function is used to pre-stretch strings by increasing the applied tension by a set percentage over the tension setting before releasing the string and re-pulling to the desired tension. This function helps to reduce the amount of tension loss in the strings over time.

Pressing the PRE-STRETCH button will toggle the Pre-stretch function on and off and display the Pre-stretch Icon and Pre-Stretch Setting. When the Pre-Stretch function is enabled, a small Pre-stretch Icon will appear on the Stringing Screen below the Tens digit of the tension setting. When the Pre-stretch function is disabled, or when the pre-stretch setting is 0%, the Pre-stretch Icon will not be visible on the Stringing Screen.



## Setting the Pre-Stretch from the Stringing Screen

To change the Pre-stretch Setting while in the Stringing Screen, press the PRE-STRETCH button once and while the Pre-stretch Icon is visible on the display, press and hold the PRE-STRETCH button again until the Pre-stretch Setting is highlighted. Press any of

the F2, F3 or F4 keys to increase the Pre-stretch Setting in 1% increments and any of the F6, F7 or F8 keys to decrease the Pre-stretch Setting in 1% increments. When the desired Pre-stretch Setting is displayed, press ENTER to save the Pre-stretch Setting for the active Memory Setting.

**NOTE: Selectable Pre-stretch Settings range from 0% to 30% in 1% increments.**



## Setting the Pre-stretch from the Settings Screen

To change the Pre-stretch Setting from the Settings Screen, press F1 to display the Settings Screen. After the Settings Screen appears on the display, press the PRE-STRETCH button to highlight the Pre-stretch Setting above the Pre-stretch Icon. Press any

of the F2, F3 or F4 keys to increase the Pre-stretch Setting in 1% increments and any of the F6, F7 or F8 keys to decrease the Pre-stretch Setting in 1% increments. When the desired Pre-stretch Setting is displayed, press ENTER to accept and save the Pre-stretch Setting for the active Memory Setting. If no other buttons are pressed within 10 seconds the display will return to the Stringing Screen. Pressing the ESC or RETURN button will immediately return to the Stringing Screen.

# MACHINE FUNCTIONS



## Knot String Function

The Knot String function is used to increase the applied tension by a set percentage over the tension setting on the last main string or cross string pulled before tying off. This function helps to compensate for tension loss caused by the slack portion of the string from the string clamp to the tie-off knot.

Pressing the KNOT button will toggle the Knot function on and off. When the Knot function is enabled, the Knot Icon will appear on the Stringing Screen and the Blue LED will illuminate next to the KNOT button. The function will be enabled for the next pull and then will automatically disable itself.



## Setting the Knot Tension from the Stringing Screen

To change the Knot Setting while in the Stringing Screen, press the KNOT button once and while the Knot Icon is visible on the display, press and hold the Knot button again until the Knot Setting is highlighted above the Knot Icon. Press any of the F2, F3 or F4 keys to increase the Knot Setting

in 1% increments and any of the F6, F7 or F8 keys to decrease the Knot Setting in 1% increments. When the desired Knot Setting is displayed, press ENTER to save the Knot Setting for the active Memory Setting.

**NOTE: Selectable Knot Settings range from 0% to 30% in 1% increments.**



## Setting the Knot Tension from the Setting Screen

To change the Knot Setting from the Settings Screen, press F1 to display the Settings Screen. After the Settings Screen appears on the display, press the KNOT button to highlight the Knot Setting above the Knot Icon. Press any of the F2, F3 or F4 keys to increase the Knot Setting in 1% increments

and any of the F6, F7 or F8 keys to decrease the Knot Setting in 1% increments. When the desired Knot Setting is displayed, press ENTER to accept and save the Knot Setting for the active Memory Setting. If no other buttons are pressed within 10 seconds the display will return to the Stringing Screen. Pressing the ESC or RETURN button will immediately return to the Stringing Screen.

# STRING GRIPPER OPERATION

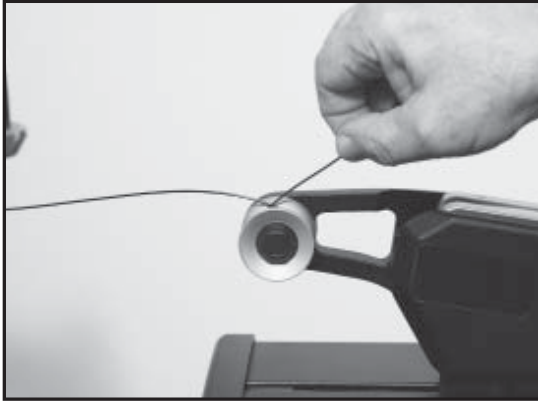

## Auto-Start Quick Closing String Gripper Operation

The Quick Closing gripper will automatically tension string without the need to press a tension lever or button. To tension a string, wrap the string clockwise around the string guide and insert the string between the string gripper plates. Excessive slack in the string should be removed before applying tension. Tension string by placing the string between the parallel gripper jaws and pulling the string perpendicular to the gripper plates. As the gripper jaws begin moving forward they will engage the sensor

built into the front of the gripper housing and the gripper will automatically pull tension. To release tension on the string depress the tension lever switch or use the foot pedal switch.

For adjustment of the parallel plates, see "Setting the Gripper Plate Spacing" on page 27.

**CAUTION:** NEVER TENSION A STRING WITH YOUR FINGERS BETWEEN THE STRING AND THE STRING GUIDE AS SERIOUS INJURY COULD RESULT IF YOUR FINGER IS CAUGHT BETWEEN THE STRING AND STRING GUIDE DURING TENSIONING. PUSH ANY BUTTON TO RELEASE TENSION.

# MOUNTING THE FRAME



## Adjusting the Frame Mounting Stands

To adjust the spacing between the Mounting Stands, turn one of the knobs located at either end of the Turntable. There is an arrow on the face of each knob indicating the turning direction that will “Tighten” the mounting points and move the Mounting Stands further apart to bring the posts of the Frame Support Slides closer to the inside surface of the racquet head. Turning the knobs in the opposite direction will move the Mounting Stands closer together. When

mounting a racquet, adjust the Mounting Stand spacing until the posts of the Frame Support Slides fit inside the head of the racquet. Lower the racquet over the posts and adjust the mounting stands until the posts just make contact with the inside surface of the racquet head at its center points located at 6 and 12 o'clock.

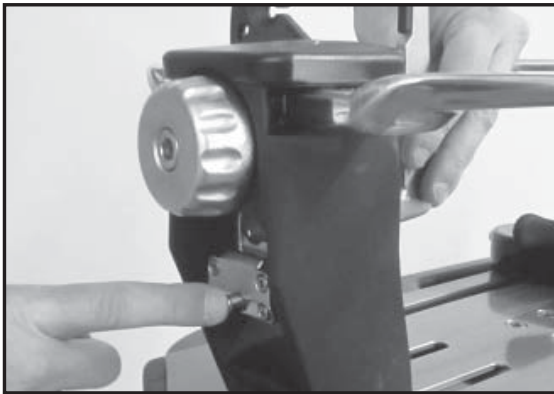

## Adjusting the Frame Support Slide

Center the racquet over the Mounting Stands. To adjust the distance from the inside of the mounting stand and the frame support, press the quick release button on the back side of the Mounting Stand, located below the Shoulder Support Knob, and lock the Frame Support Slide into one of the three positions depending on the shape and head size of the racquet. Check to make sure the quick release lock is fully seated in the groove on the Frame Support hex shaft.

Tighten the Frame Supports on the racquet by turning the Mounting Stand Adjustment Knob at either end of the Turntable until they are snug.



## Securing the Shoulder Supports

To secure the racquet frame with the Shoulder Supports, rotate the large Adjustment Knobs on the outside of the Mounting Stands clockwise to bring the mounting arms together. Adjust until firm contact is made between the Shoulder Supports and the frame. Re-adjust the stand position as needed to ensure that the Frame Supports are in firm contact with the racquet at 6 and 12 o'clock. Do not over tighten any of the supports as racquet deformation may occur. The supports should be

tightened to the point where the racquet frame will not move in the Mounting System when the handle is grasped and attempts are made to move it. Should any supports lose contact with the frame while stringing, they should be re-tightened.



# MOUNTING THE FRAME



## Frame Shoulder Support Adjustment

The shoulder supports are designed to rotate and can be adjusted to provide maximum support to the racquet frame. Rotate the support so that the pads contact the frame squarely when the arms are closed against the racquet. Should the shoulder supports block string holes, adjust the frame support slides to re-position the racquet between the arms so the shoulder supports make contact with the racquet between grommet holes.

# STRING CLAMP OPERATION

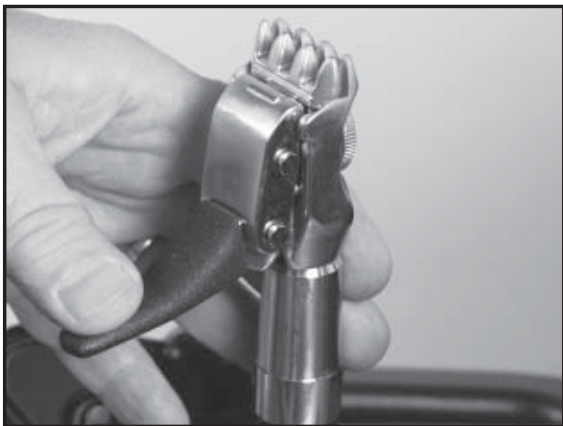

## String Clamp Operation

The String Clamps are a dual action design where the String Clamp and Clamp Base operate independently of one another.

To clamp a string, lift the String Clamp and place the string between the jaws and depress the String Clamp Lever to secure the string. The clamping pressure applied to the string should be adjusted to provide sufficient pressure to secure the string when subjected to the desired pulling tension. The textured surface of the teeth provide for increased friction between the clamps and the string to allow for reduced

clamping pressure while securing and holding the string under tension.

**Note that excessive pressure can damage both the strings and String Clamp.**

# AUTO-RELEASE BASE OPERATION



## Clamp Base Operation

To lock the Clamp Base to the Turntable, rotate the Clamp Base locking lever clockwise until it locks into place. Note that to lock the clamp base lever, the string clamp must be lifted up to disengage the release mechanism located at the base of the tube.

To release the Clamp Base from the Turntable, lower the string clamp into the tube to engage the release mechanism, or press the rocker lever on the top of the clamp base lever.

To adjust the Clamp Base refer to page 23.

# STRINGING THE FRAME

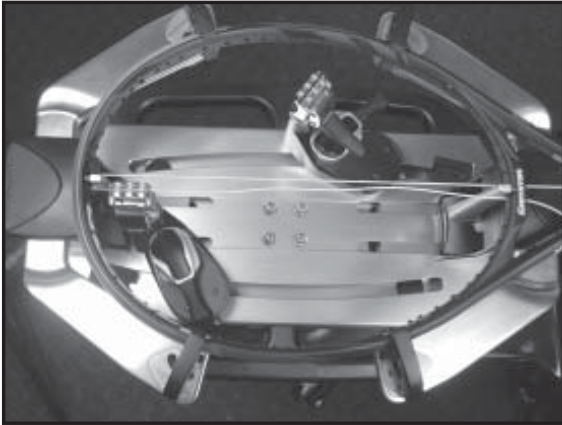

## Stringing the Mains

Follow the manufacturer's recommended stringing pattern for one or two piece stringing.

To determine which end of the racquet to start installing the string count the number of grommet holes located in the throat bridge. If there are 2 or 6 holes start main strings at the center 2 holes of the throat bridge. If there are 4 or 8 holes start the main strings at the center 2 holes at the tip of the racquet.

To begin stringing the main strings, thread the two ends of the string through the two center holes at the appropriate end of the frame and continue through the opposite center holes. Thread one end of the string through the adjacent grommet hole and pull excess by hand. Secure one of the strings using a string clamp.

To begin stringing the main strings, thread the



## Pulling Tension

Remove excessive slack in the string before applying tension. To apply tension to the main string, wrap the string clockwise around the String Guide to ensure that the proper tension will be applied to the string.



Insert the string between the Auto-Start Gripper Plates and apply tension to the string. Pull the string towards you at a slight angle to engage the sensor in the front of the gripper to automatically tension the string. As the gripper plates slide to the left, they close and will grip the string. The Gripper will move to the right, away from the racquet, and gradually apply tension to the string. To release the tension on the string depress the tension release lever at the rear of the gripper or use the Foot Pedal switch.

For adjustment of the parallel plates, see "Setting the Gripper Plate Spacing" on page 27.

**CAUTION: NEVER TENSION A STRING WITH YOUR FINGERS BETWEEN THE STRING AND THE STRING GUIDE AS SERIOUS INJURY COULD RESULT IF YOUR FINGER IS CAUGHT BETWEEN THE STRING AND STRING GUIDE DURING TENSIONING. PUSH ANY BUTTON TO RELEASE TENSION.**

# STRINGING THE FRAME



Tension Indicator LEDs

As tension is applied to the string, the 4 Tension Indicator LEDs on the Control Panel will progressively flash until all 4 are lit indicating that the set tension has been reached. The 4 LEDs will remain lit and the Gripper will continue to pull to maintain the set tension in the string until the string is clamped off and the tension is released.

To release the string after clamping, press the Tension Lever Switch or Foot Pedal Switch. If the String Gripper does not release the string, push the gripper plates to the right to help disengage and release the string from the Gripper Plates

**NOTE:** The tensioner has a built in safety that will shut down the motor if a string is not released within 60 seconds from the time the tensioner is activated. After 30 seconds, an alarm will sound and a 30 second count-down will begin on the display. An alarm will sound again at 20 seconds and at every second from 10 until zero. After 60 seconds, the motor will stop pulling, the alarm will sound in a series of beeps and the 4 Tension Indicator LEDs will begin to flash until the string is released. To release the string, press the Tension Lever Switch or Foot Pedal Switch. Note that after the motor is shut down, the set tension in the string will no longer be maintained.



# STRINGING THE FRAME



## Clamping the First Main String

Secure the tensioned main string using the remaining fixed clamp. Repeat the procedure for all of the remaining main strings and tie off at the appropriate holes following the racquet manufacturers specifications.

This will determine the starting point for the cross strings. If applicable, tie the first cross string using an appropriate starting knot.



## Weaving the Cross Strings

Weave the cross strings over and under the main strings being careful to alternate the weave of each consecutive cross string to be opposite of the previously installed cross string.

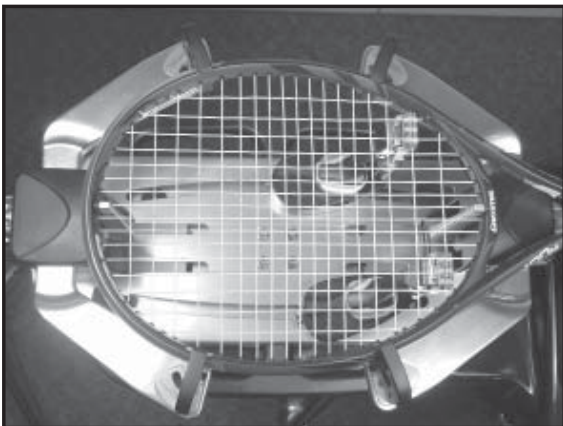

## Completing the String Job

Once the final cross string is tensioned and clamped, tie off at the appropriate hole specified by the racquet manufacturer. Remove the frame from the Mounting System by loosening the Shoulder Supports and Frame Supports.

# STRING LENGTH METER OPERATION



## String Length Meter

Press the String Length Meter (SLM) button to enable the SLM function and display the SLM screen. To change the measurement units from Feet (FT) and meters (M) press the SLM button to toggle between FT and M.

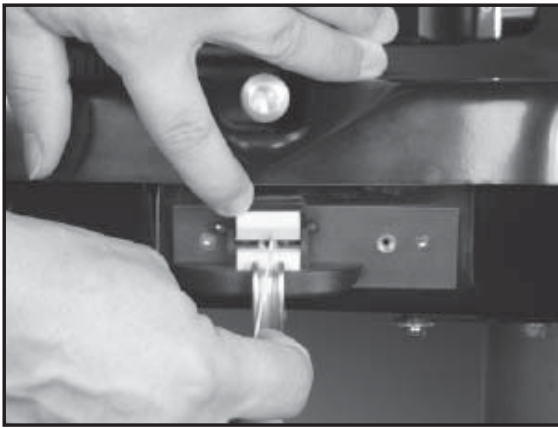

To measure a length of string from a reel or set of string, insert the end of the string through the loop from the backside of the string guide attached to the front of the SLM. Lift the clamp pad and insert the string through the entry hole on the face plate of the SLM. Continue to feed the string into the entry hole until it exits the SLM through the hole on the right side and release the clamp pad. (In addition to aligning the strings with the entry to the SLM, the felt clamp pads apply a slight amount of pressure to the string and wipe down the surface of the string to prevent debris from entering the SLM).

**NOTE: When measuring thin strings such as badminton strings, apply light finger pressure to the clamp pad to provide some back pressure while pulling the string through the meter to prevent slipping and obtain more accurate measurements.**

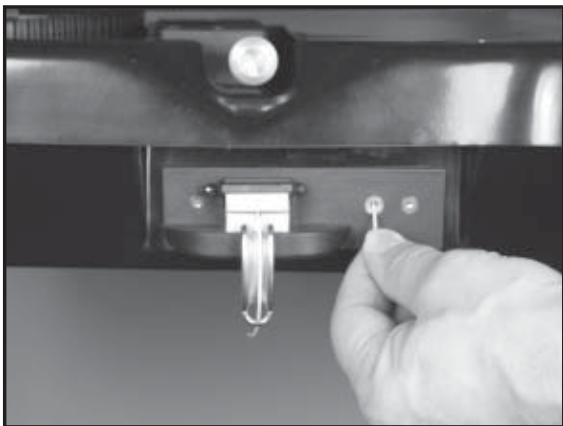

When the end of the string exits through the hole on the right, press the ENTER button to “Zero” the String Length Meter, and the length of string will be measured from the point on the string located at the edge of the exit hole. Pull the end of the string at a slow steady rate and the SLM will begin measuring the length of string as it is pulled through the SLM and indicate the measurement on the display. When the desired length of string is measured, cut the string at the edge of the exit hole.

**NOTE: When reaching the end of a string, pull the string through the SLM slowly to avoid inaccurate measurement.**

The measurement accuracy of the SLM is approximately +/- 0.5% of the indicated value for thicker strings when the tension is set for 35 lbs and higher and badminton strings when the tension is set for under 35 lbs prior to measurement.

# ADDITIONAL FEATURES



## **Turntable Brake**

The Turntable may be locked in any position.

To lock the Turntable Brake pull the brake lock pin OUT.

To release the Turntable Brake push the brake lock pin IN.



## **Turntable Clutch**

To adjust the free rotation of the turntable, turn the Turntable Clutch bolt located on the left end of the base clockwise to add friction and restrict rotation or turn the Turntable Clutch bolt counter-clockwise to reduce the friction and allow the turntable to rotate more freely.



## **Badminton Shoulder Support Cover**

When stringing badminton racquets, slide the Badminton Shoulder Support Cover over the Shoulder Supports. There is no need to remove the Tennis Shoulder Supports.

**Note: Special three finger Badminton Frame Supports for the head and throat of the racquet are also available as an optional accessory to reduced the pressure between the frame support and badminton frame as strings are installed under tension.**

# PATHFINDER AWL

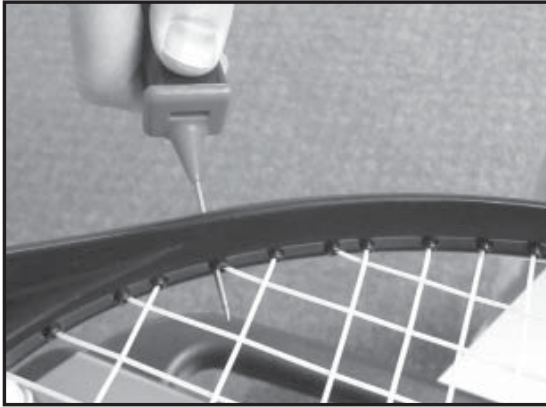

The machine includes the Pathfinder Stringing Awl which creates a pathway between or around strings to make inserting a string through blocked grommets easier and quicker.

Insert the awl through the grommet hole in the same manner as for traditional awls. The Pathfinder Awl must be in the closed position before insertion.

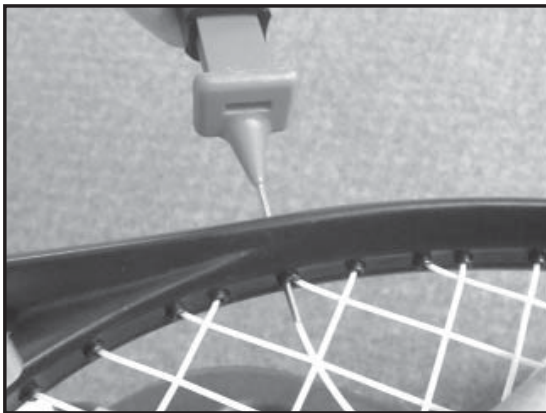

Once the awl is inserted, pull the handle of the awl outward while holding the tip section in place. This leaves the outer sheath in the grommet hole. Insert the end of the string into the outer sheath.

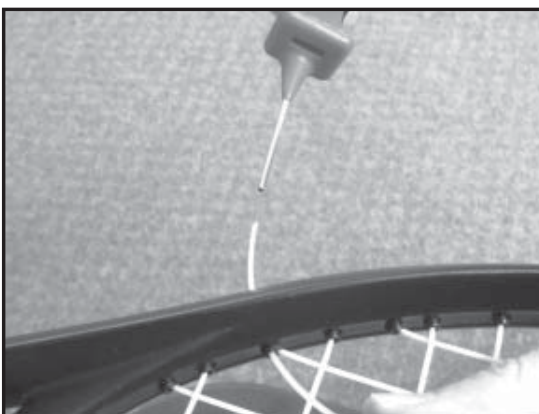

While holding the string, slowly pull the sheath out of the grommet hole to leave the free end of the string exposed.



# MAINTENANCE & ADJUSTMENTS



## Tension Calibration Procedure

During power up press both ESC and ENTER buttons to enable the calibration mode.

The display will show 22 lbs or 10 kgs. KG/LBS can be changed at any time by pressing the LB/KG Button.

Using a Tension Calibrator, apply tension to the calibrator and adjust the value on the display up or down to match the reading on

the calibrator. Press the ENTER button to confirm and release the tension on the calibrator.

When the Gripper returns to the home position the display will now show 44 lbs or 20 kgs. Apply tension to the calibrator and adjust the value on the display up or down to match the reading on the calibrator. Press the ENTER button to confirm and release the tension on the calibrator.

When the Gripper returns to the home position the display will now show 66 lbs or 30 kgs. Apply tension to the calibrator and adjust the value on the display up or down to match the reading on the calibrator. Press the ENTER button to confirm and release the tension on the calibrator.

When the Gripper returns to the home position the display will now show 88 lbs or 40 kgs. Apply tension to the calibrator and adjust the value on the display up or down to match the reading on the calibrator. Press the ENTER button to confirm and release the tension on the calibrator. The Calibration procedure is now complete.

**NOTE: If ESC is pressed at any time during calibration, the calibration procedure will be terminated and no new calibration data will be saved.**

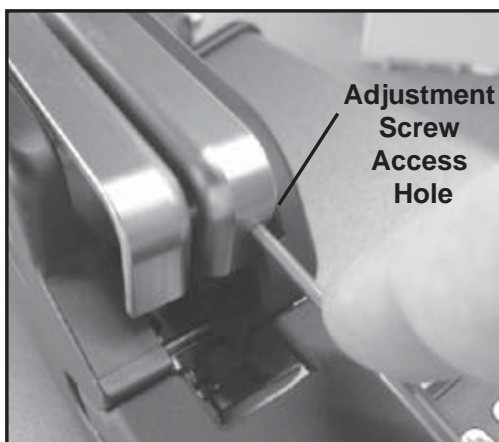

## Gripper Plate Spacing Adjustment

The Gripper Plates of the String Gripper are adjustable to accommodate various string gauges and types of string. If the string slips through the Gripper Plates while pulling tension, insert a 2.5mm hex wrench through the access hole on the back of the right Gripper Plate and into the Adjustment Screw. Turn the Adjustment Screw clockwise to increase the compression on the string. If too much pressure is applied to the string while pulling tension, rotate the Gripper Adjustment Screw counter-clockwise to reduce the compression on the string. The Gripper Plates are properly adjusted when there is enough pressure to securely hold the string without slipping and without excessively compressing the string.

**TIP: If you turn off the machine with the Gripper located at the far right side of the track, it is easier to access the Adjustment Screw.**

# MAINTENANCE & ADJUSTMENTS

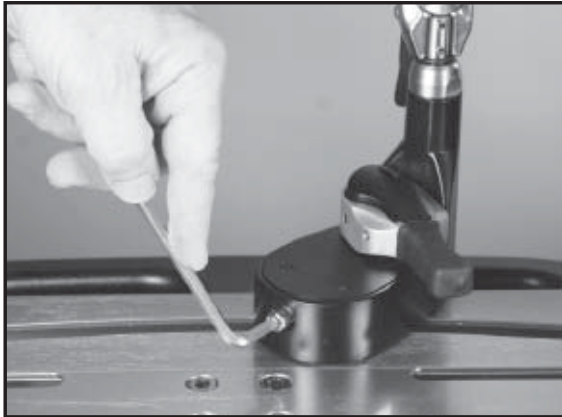

## Auto-Release Clamp Base Adjustment

If the Clamp Bases slip on the Turntable, the base locking levers may need adjusted. Turn the cap screw located on the end of the Clamp Base clockwise to increase clamping pressure and counterclockwise to reduce it. If frequent adjustment is needed, try loosening the Locking Lever Adjustment Screw and tighten the two screws located on the underside of the Clamp Base. Re-tighten the Locking Lever Adjustment Screw and adjust as needed.



## Clamp Base Removal

Clamp Bases can be removed from the Turntable for maintenance or cleaning by removing the Clamp Stop located at the end of the slot in the Turntable. To remove the Clamp Stop, remove the two screws holding the Clamp Stop in place from the underside of the Turntable. Lift the Clamp Stop out of the slot, slide the Clamp Base to the end of the slot and lift it out. Replace the Clamp Base and clamp stop in reverse order.

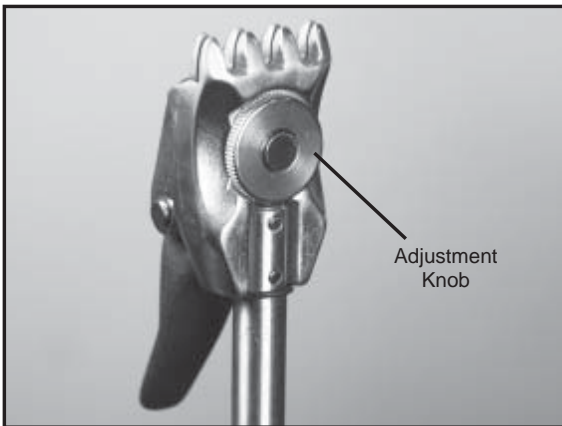

## Adjusting String Clamp Jaw Spacing

The String Clamps will need minor adjustments according to what string type, construction, and gauge you are using. To adjust the gap (clamping pressure) between the clamp jaws, insert the string through the racquet as if you were beginning the main strings. Clamp the strings and pull tension. If the string slips through the jaws of the clamp, tighten the clamp by turning the Adjustment Knob, in the clockwise direction. If the clamp leaves impressions in the string, it may be excessively tight and should be adjusted by

turning the Adjustment Knob counter clockwise to increase the gap between the jaws.

**NOTE: Due to the bearings used in the clamp lever the action of the clamp lever is very light making it easy to apply excessive clamping pressure. Clamps that are set too tight can damage the string as well as the string clamp jaws.**

The clamp jaws should be cleaned periodically to be free from dirt, oil, and any residual string coating for them to grip properly. The cleaning stone supplied with the machine is excellent for removing build-up on the diamond coated surfaces. Rub the gripping surfaces with the cleaning stone and remove any residual dust with a brush or cloth and isopropyl alcohol.

# TROUBLESHOOTING TIPS

<u>PROBLEM</u>	<u>SOLUTION</u>
String slips in clamps	<ul style="list-style-type: none"><li>- Adjust gap between clamp jaws</li><li>- Clean clamp jaws</li></ul>
String slips in gripper	<ul style="list-style-type: none"><li>- Adjust gripper jaw stop screw</li><li>- Clean gripper jaws</li></ul>
String clamp base slips on turntable	<ul style="list-style-type: none"><li>- Clean bottom of clamp &amp; top of turntable with alcohol</li><li>- Adjust clamp base locking nut</li></ul>
String tension too tight or too loose	<ul style="list-style-type: none"><li>- Check tension using a tension calibrator, adjust machine calibration if necessary</li></ul>
Electrical system does not function	<ul style="list-style-type: none"><li>- Check power source</li><li>- Check power cord connections</li></ul>

## CARE & CLEANING

With time and use, the clamping surfaces of your machine may become oily or dirty and result in string or clamp slippage while stringing. Periodic cleaning of the String Clamps, String Clamp Base and String Gripper is recommended. The supplied Cleaning Stone or a knife sharpening stone works well for cleaning the diamond coated string clamping surfaces. Cleaning with a solvent such as isopropyl alcohol and a mild abrasive tool such as a toothbrush also works well to remove oily or greasy build up.



# PARTS LIST

PART #	DESCRIPTION	TOOLS & ACCESSORIES	
121	LEVELING FOOT	109	NEEDLE NOSE PLIERS*
140	MTNG STAND TOP PLATE	110	BENT NOSE PLIERS*
146A	MTNG ARM ADJUST KNOB	171	DIAGONAL CUTTERS*
203	TT BOLTS*	221	SLM PADS*
210	STRING REEL HOLD BOLT	251	HEX WRENCH SET*
211	STRING REEL HOLD SPACER	324	FOOT PEDAL SWITCH*
283	END CAP	E16	A/C POWER CORD*
285	TT END CAP- RIGHT	E23	AC ADAPTER*
286	TT END CAP- LEFT	MA	STRINGER'S AWL*
289	TT HANDLES	MBMSP11	BADM SHLDR SUPP COVER
299	STRING LENGTH METER	MFSP13	FRAME SUPP PAD SET
304	SC TT KNOB		6 FRAME PADS
320	BRAKE RING		2 BAD SLIDE ON "H" PADS
327	TT PIN	MMSPP13	SHOULDER SUPP PADS
340	SUSP ARM TOP CAP	MPG	STARTING CLAMP*
341	SUSP ARM BOTTOM CAP	MPSA	PATHFINDER AWL*
361	SC TURNTABLE TT8-6PT	MGEMC	MACHINE COVER *
371	A220 SHOULDER V-MOUNT BLK		*(NOT SHOWN)
383	A500 SUSP SUPPORT ARM LEFT		
384	A500 SUSP SUPPORT ARM RIGHT		
385	A500 SUSP MOUNTING STAND (BLK)		
386	A500 FRAME SUPP SLIDE		
398	AUTO-START QUICK GRIPPER		
399	9900 ELS TENSIONER		
400	9900 TENSIONER LEFT SIDE CAP		
401	9900 TENSIONER RIGHT SIDE CAP		
402	9900 ELS FRP UPPER COVER		
403	9900 ELS BASE FRAME	MBFS15	BADM HEAD FRAME SUPP
404	9900 ELS FRP LOWER COVER	MFSC	FLOOR STAND CASTERS
405	9900 ELS TOOL TRAY PAD	MTC	CALIBRATOR
406	TT CLUTCH BOLT	SGSM	STRINGER'S MAT
407	TT CLUTCH SPRING	MBMSS10	BADM MNTNG SYS UPGRADE
408	A500 SHLD SUPP BOLT/SPRING SET	MGCWP16	GAMMACARE SERVICE PLAN
409	REEL HOLDER KNOB wGRIP		
410	ELECTRIC FL STND COLUMN ASSY		
411	LEG FOR EXTRUDED FLOOR STAND		
412	M8X30 FLAT HEAD SCREW		
413	M8X35 CAP SCREW		
414	9900 ELS BRAKE BOX		
E89	KEY PAD / ELECTRONICS		
MARC10	AUTO-RELEASE CLAMP BASE		
MMSC13	4T UNIVERSAL STRING CLAMP		

## OPTIONAL TOOLS & ACCESS

MBFS15	BADM HEAD FRAME SUPP
MFSC	FLOOR STAND CASTERS
MTC	CALIBRATOR
SGSM	STRINGER'S MAT
MBMSS10	BADM MNTNG SYS UPGRADE
MGCWP16	GAMMACARE SERVICE PLAN

# PARTS DRAWING

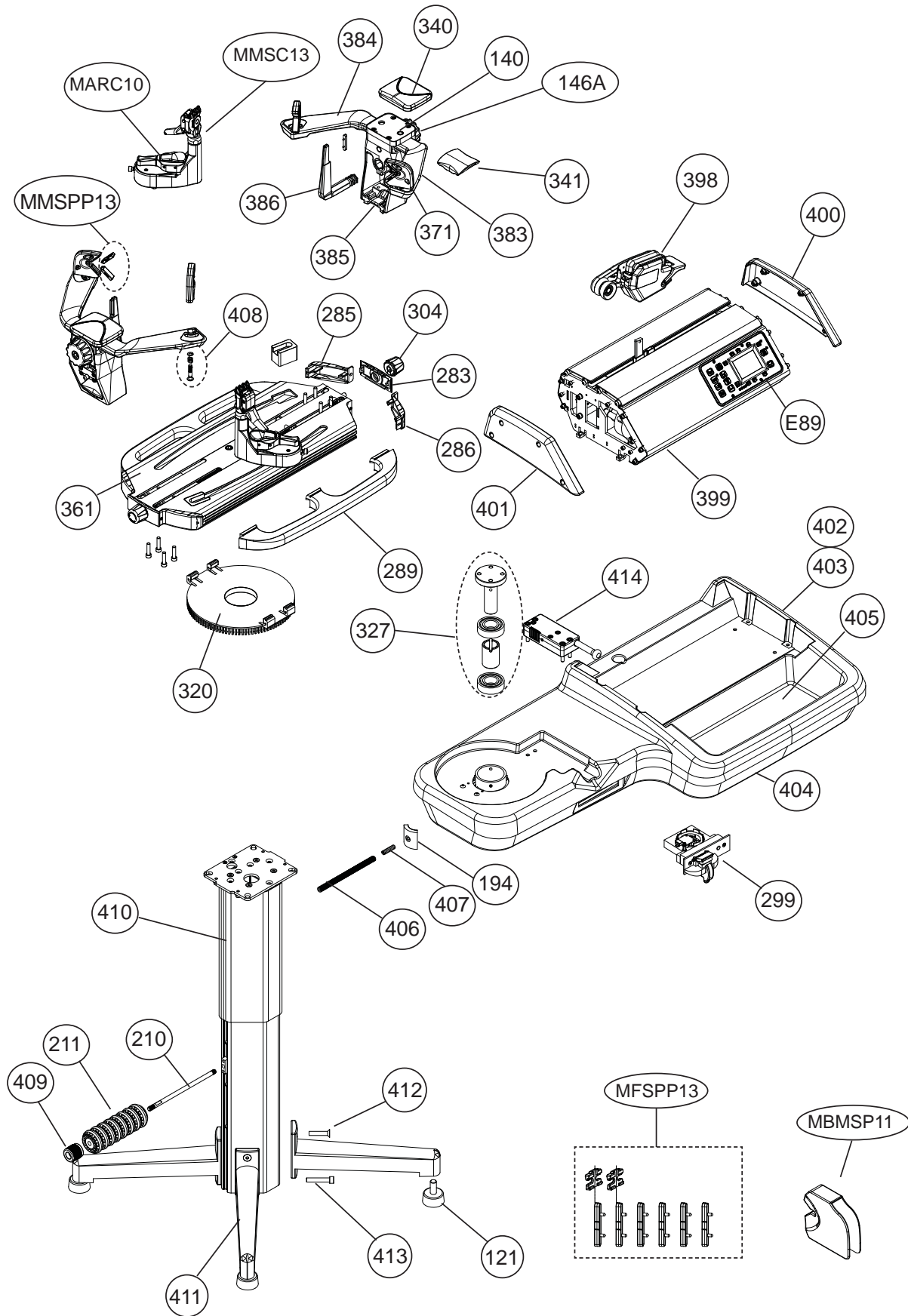



MMAN-52  
(MG99E-10)

**GAMMA SPORTS**

200 Waterfront Drive  
Pittsburgh, Pennsylvania 15222  
Phone: 800.333.0337 Fax: 412.323.0317  
Visit our website at [www.gammasports.com](http://www.gammasports.com)